

## MMA-070936-M5 7-8.5GHz, 4W Power Amplifier

### Features:

- Frequency Range: 7 – 8.5 GHz
- P1dB: 34 dBm
- P3dB: 36 dBm
- IM3 Level: -50dBc @Po=20dBm/tone
- Gain: 28.5 dB
- Vdd = 6 V
- Ids = 2000 to 4000 mA
- Input and Output Fully Matched to 50 Ω
- RoHS Compliant Surface Mount QFN 5x5mm package

### Applications:

- Communication systems
- Microwave instrumentations
- Point to Point Radios

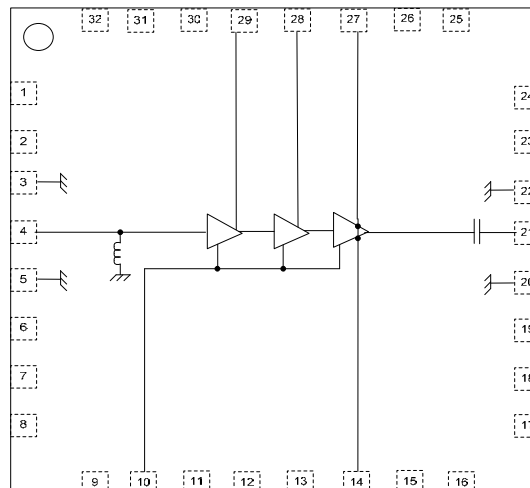

Functional Block Diagram

### Description:

The MMA-070936-M5 is a GaAs MMIC linear power amplifier with 4-Watt output power (P-3) and high gain over 7 to 8.5GHz frequency range packaged in a RoHS compliant surface mount QFN 5x5mm package. This amplifier was optimally designed for high linearity applications at 12dB back-off from P-3 condition.

### Absolute Maximum Ratings: ( $T_a = 25\text{ }^\circ\text{C}$ )\*

SYMBOL	PARAMETERS	UNITS	Min.	Max.
Vds	Drain-Source Voltage	V		6.5
Vg	Gate-Source Voltage	V	-2.1	0
Ig	First Gate Current	mA	-28	28
Pd	Power Dissipation	W		24
Pin max	RF Input Power	dBm		20
Toper	Operating Temperature	°C		-40 to +85
Tch	Channel Temperature	°C		+150
Tstg	Storage Temperature	°C		-55 to +150
Tmax	Max. Assembly Temp (20 sec max)	°C		+250

\*Operation of this device above any one of these parameters may cause permanent damage.

# MMA-070936-M5

7-8.5GHz, 4W Power Amplifier

## Electrical Specifications: *V<sub>ds</sub>=6V, V<sub>g</sub>=-0.85V, I<sub>ds</sub>=3000mA, T<sub>a</sub>=25 °C Z<sub>0</sub>=50 ohm*

Parameter	Units	Typical Data
Frequency Range	GHz	7 - 8.5
Gain (Typ / Min)	dB	28.5 / 28
Gain Flatness (Typ / Max)	+/-dB	0.5 / 0.7
Input RL(Typ/Max)	dB	15/12
Output RL(Typ/Max)	dB	15/13
Output P1dB(Typ/Min)	dBm	33/32
Output IM3 Level @Po=20dBm/tone	dBc	-50
Output Psat(Typ/Min)	dBm	36.5/36
Operating Current at P1dB (Typ/Max)	mA	3000 / 3500
Thermal Resistance	°C /W	2.7

(1) Output IM3 is measured with two tones at output power of 20 dBm/tone separated by 20 MHz.

# MMA-070936-M5

7-8.5GHz, 4W Power Amplifier

## Typical RF Performance: $V_{ds}=6V$ , $V_g=-0.85V$ , $I_{ds}=3000mA$ , $Z_0=50\text{ ohm}$ , $T_a=25\text{ }^\circ\text{C}$

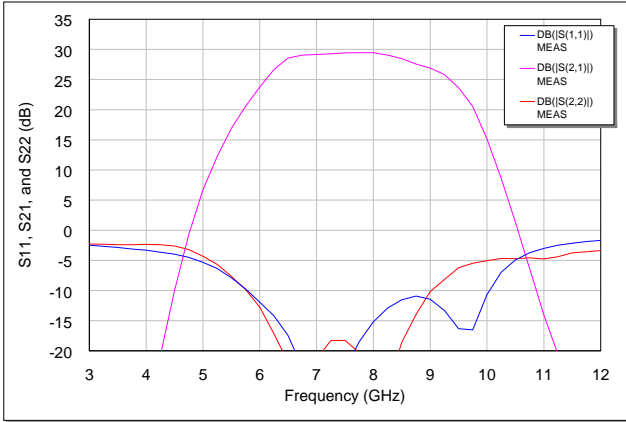

S11[dB], S21[dB], and S22[dB] vs. Frequency

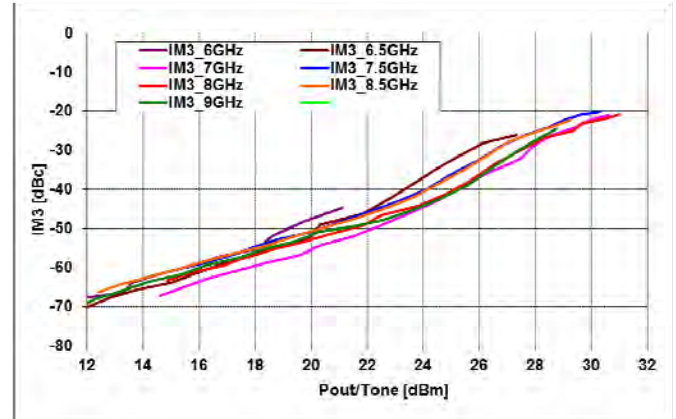

IM3 Level [dBc] vs. output power/ tone [dBm]

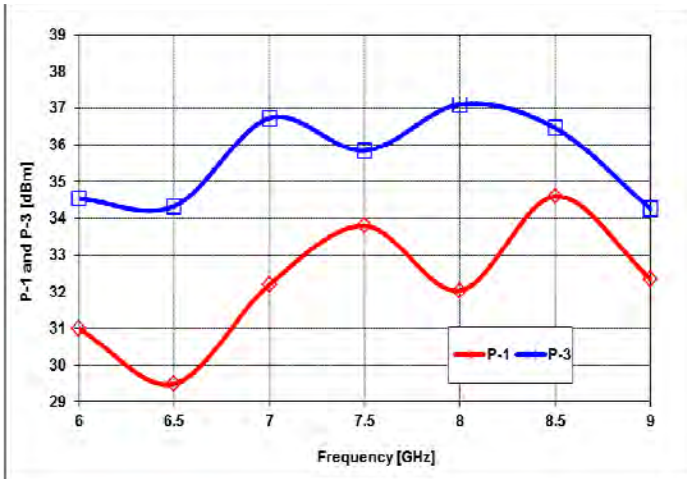

P-1 and Psat vs. Frequency

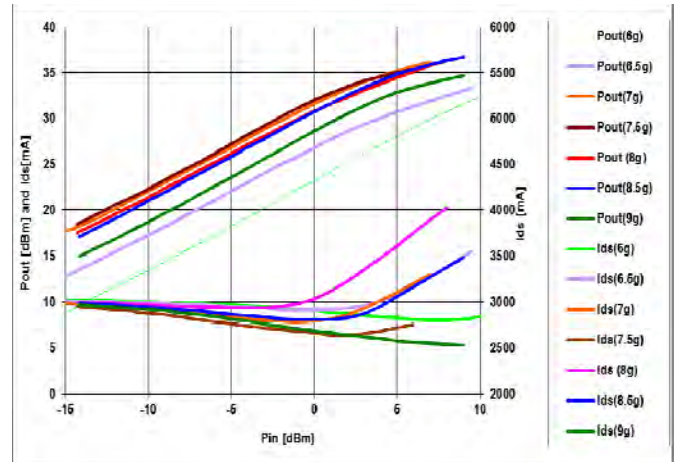

Pout[dBm], and Ids[mA] vs. Input power [dBm]

### Typical Bias Dependent RF Performance:

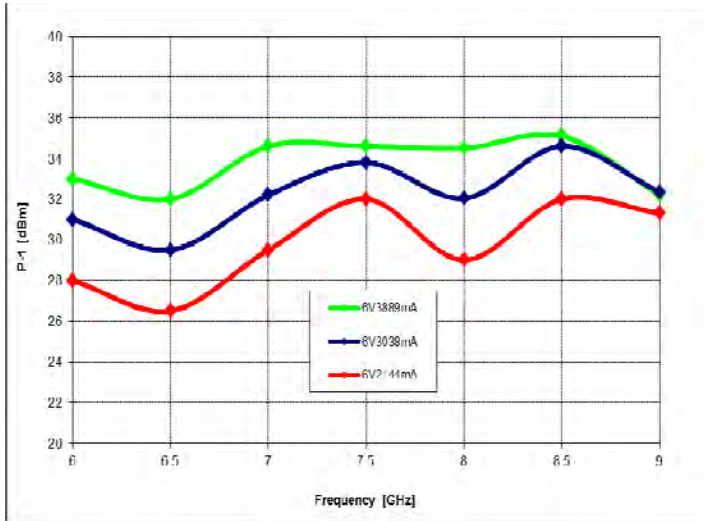

Bias dependent P1 vs. Frequency

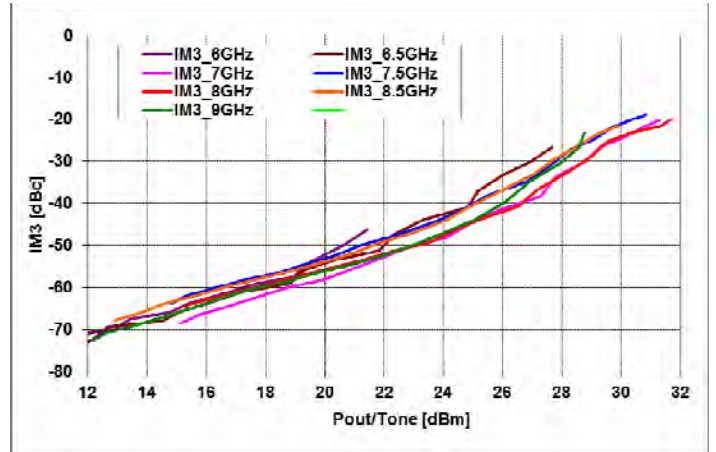

IM3 Level [dBc] vs. output power/tone [dBm]

@Vds=6V, Idsq=3.8A

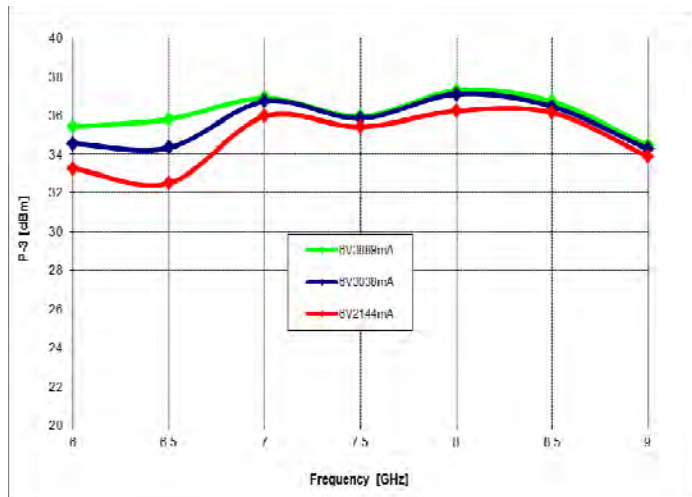

Bias dependent P-3 vs. Frequency

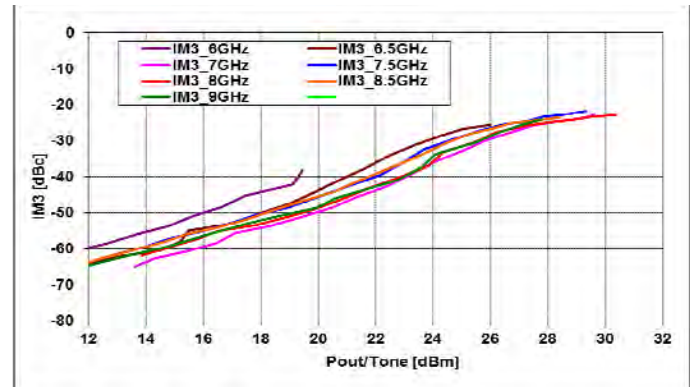

Pout[dBm], and Ids[mA] vs. Input power [dBm]

@Vds=6V, Idsq=2.1A

### **Applications**

The MMA-070936-M5 MMIC power amplifier is designed for use as a power stage amplifier in microwave transmitters. It is ideally suited for 7 to 8.5GHz band point to point radio applications requiring a flat gain response and excellent linearity performance. This amplifier is provided as a 5x5mm QFN package, and the packaged amplifier is fully compatible with industry standard high volume surface mount PCB assembly processes.

### **Biassing and Operation**

The recommended bias conditions for best performance for the MMA-070936-M5 are  $V_{DD} = 6.0V$ ,  $I_{dsq} = 3000mA$ . Performance improvements are possible depending on applications. The drain bias voltage range is 5 to 6V and the quiescent drain current biasing range is 2000mA to 4000mA. A single DC gate supply connected to  $V_g$  will bias all the amplifier stages. Muting can be accomplished by setting  $V_g$  to the pinch-off voltage ( $V_p = -2V$ ). The gate voltage ( $V_g$ ) should be applied prior to the drain voltage ( $V_{d1}$ ,  $V_{d2}$ ,  $V_{d3}$ ) during power up and removed after the drain voltage during power down. The RF input port is connected internally to the ground for ESD protection purpose; therefore, an input decoupling capacitor is needed if the preceding output stage has DC present. The RF output is DC decoupled internally. Typical DC supply connection with bi-passing capacitors for the MMA-070936-M5 is shown in following pages.

### **Assembly Techniques**

GaAs MMICs are ESD sensitive. ESD preventive measures must be employed in all aspects of storage, handling, and assembly. MMIC ESD precautions, handling considerations, die attach and bonding methods are critical factors in successful GaAs MMIC performance and reliability.

### Package Pin-out:

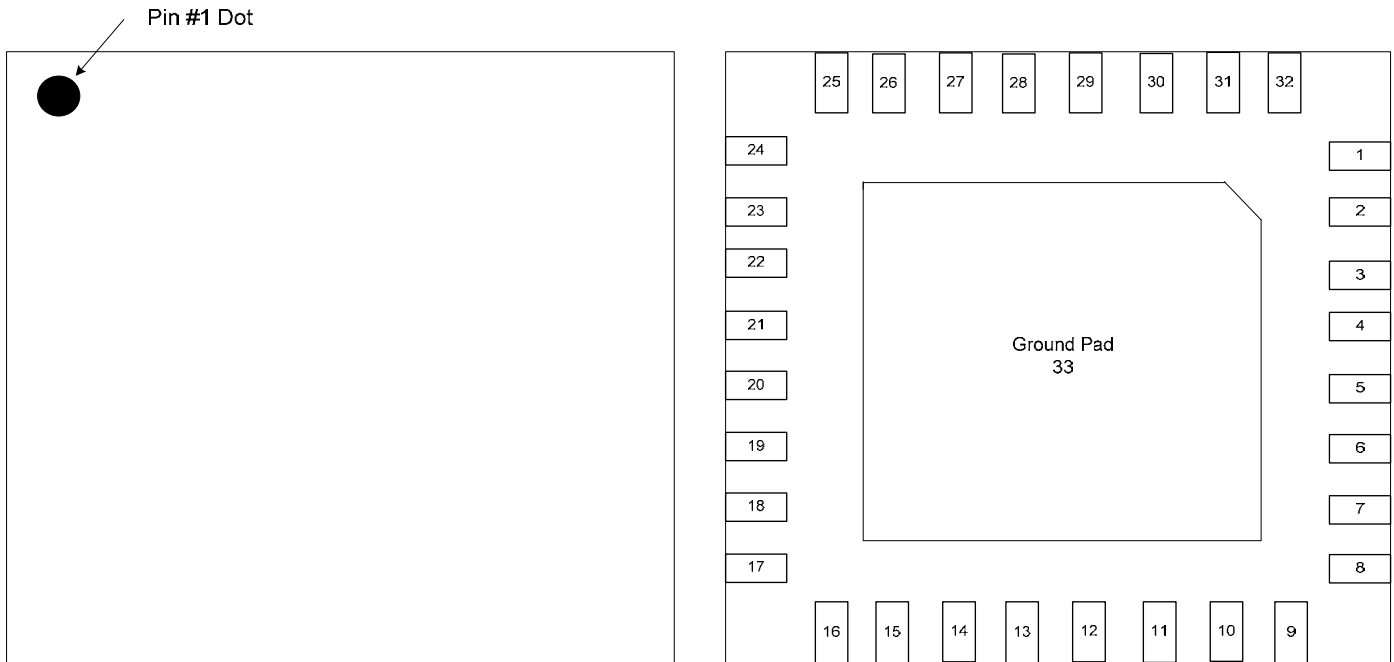

Pin	Description
4	RF Input
21	RF Output
10	Vg
29	Vd1
28	Vd2
14, 27	Vd3
1, 3, 5, 8, 9, 16, 17, 20, 22, 24, 25, 32, 33	Ground
2, 6, 7, 11, 12, 13, 15, 18, 19, 23, 26, 30, 31	N/C

**Mechanical Information:**

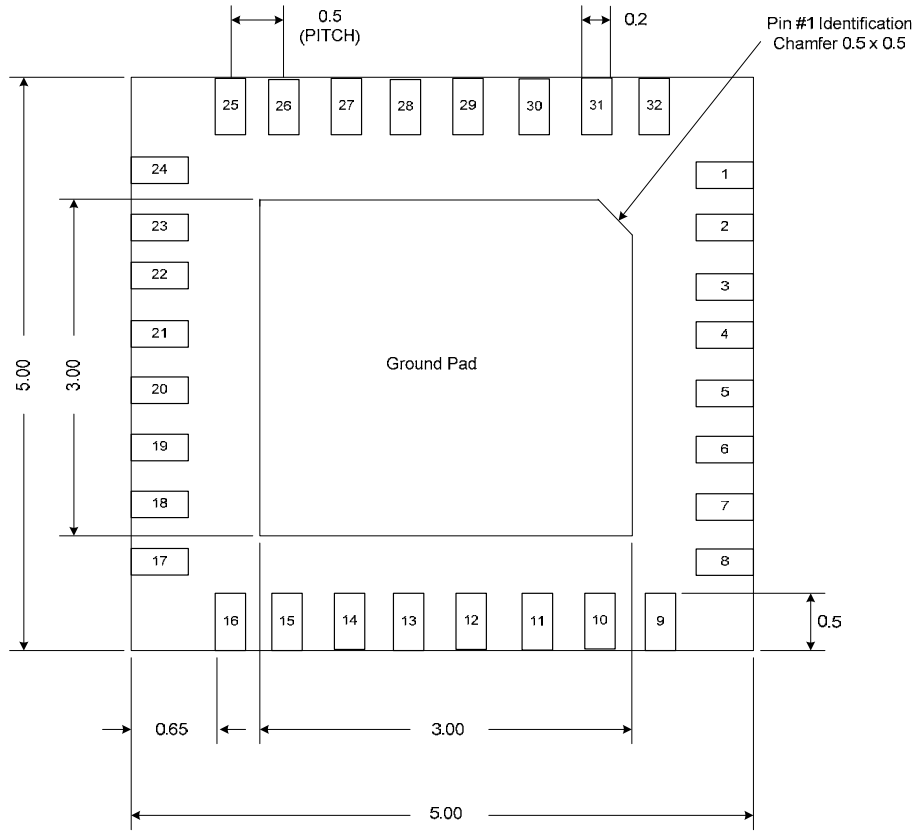

BOTTOM VIEW

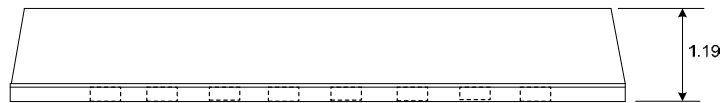

SIDE VIEW

The units are in [mm].

## Application Circuit:

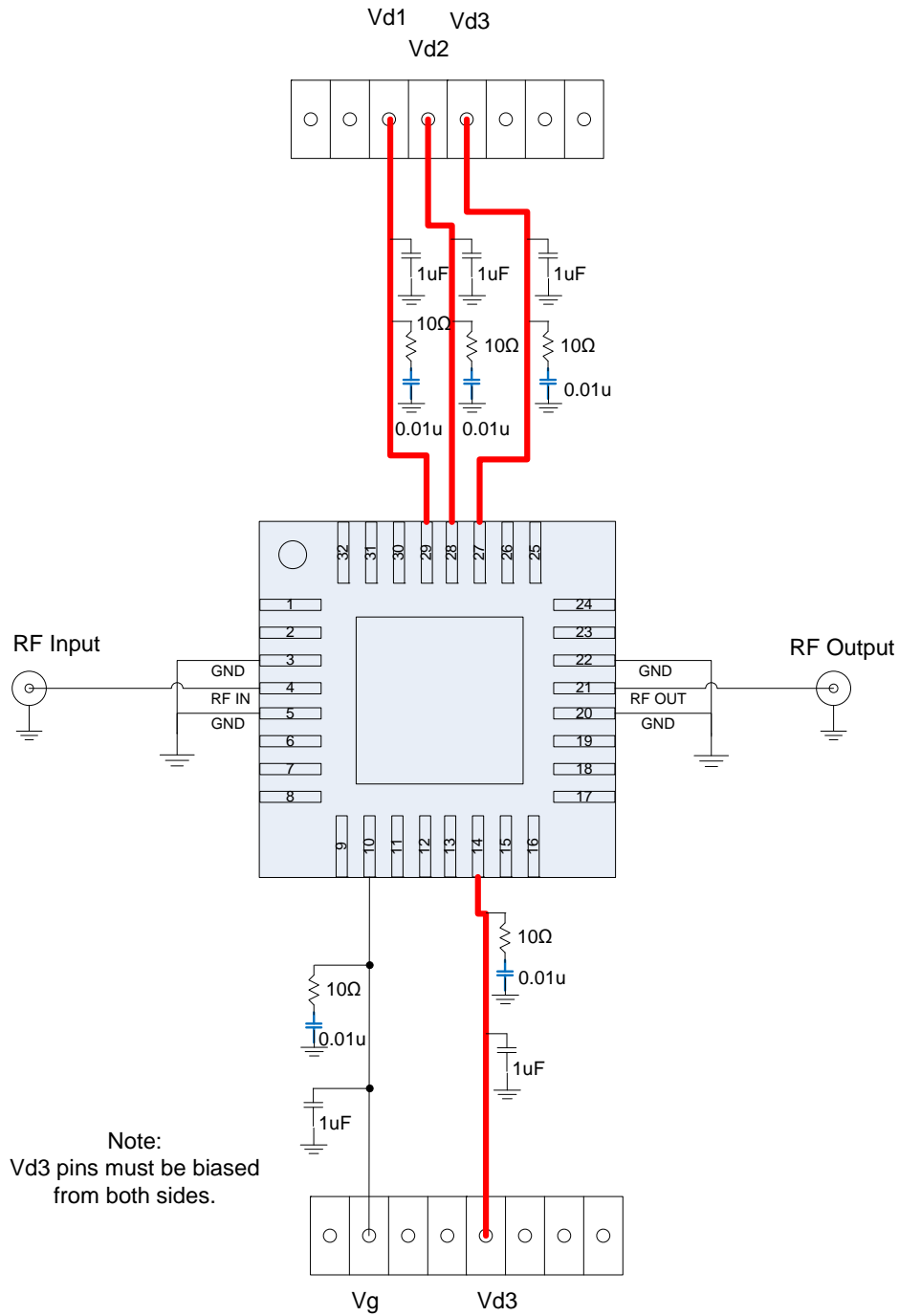



### Recommended Application Board Design:

Board Material is 10mil (Dielectric) thickness Rogers 4350B with 0.5oz copper clads.

Board is soldered on a gold plated solid copper block and adequate heat-sinking is required for 24W total power dissipation.

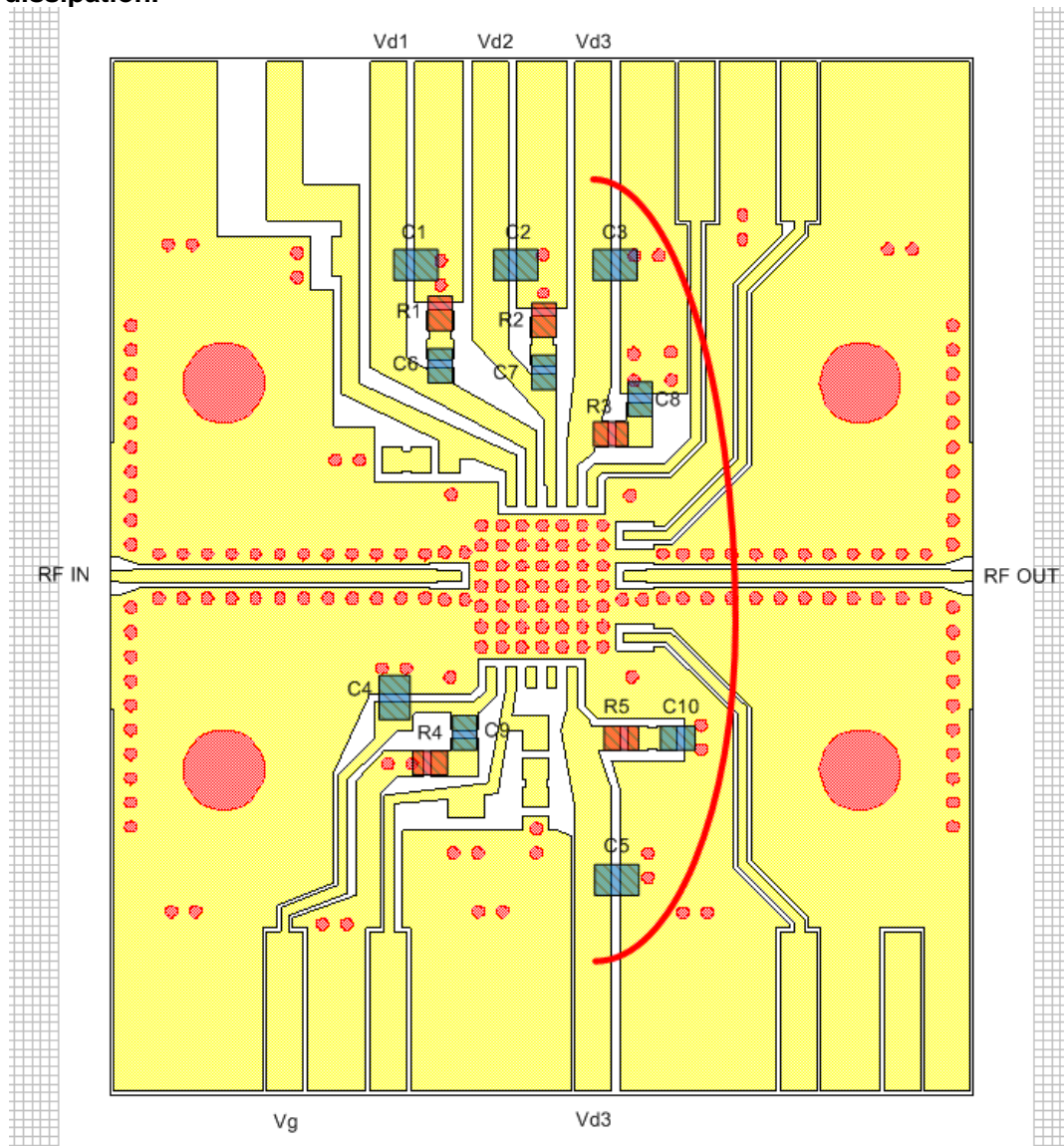

Part	Description
C1, C2, C3, C4, C5	1uF capacitor (0603)
C6, C7, C8, C9, C10	0.01uF Capacitor (0402)
R1, R2, R3, R4, R5	10Ω Resistor (0402)

### Recommended Application Board Design:

Board Material is 10mil (Dielectric) thickness Rogers 4350B with 0.5oz copper clads. The board material and mounting pattern, as defined in the data sheet, optimizes RF performance and is strongly recommended.

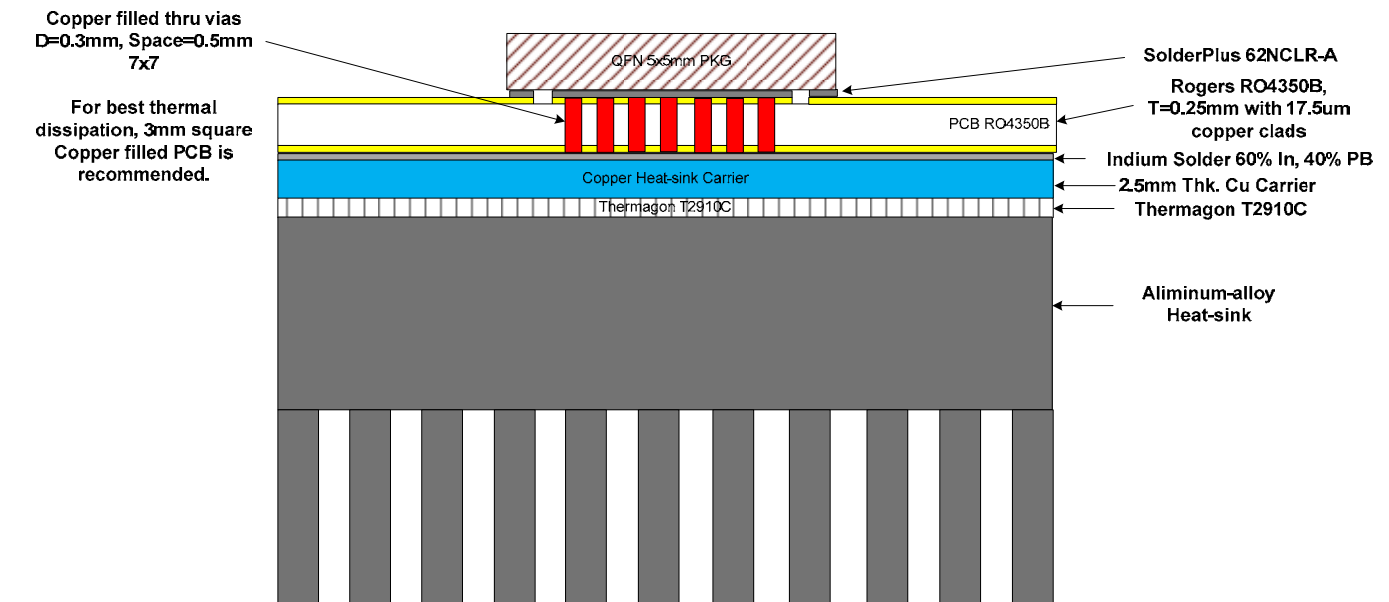
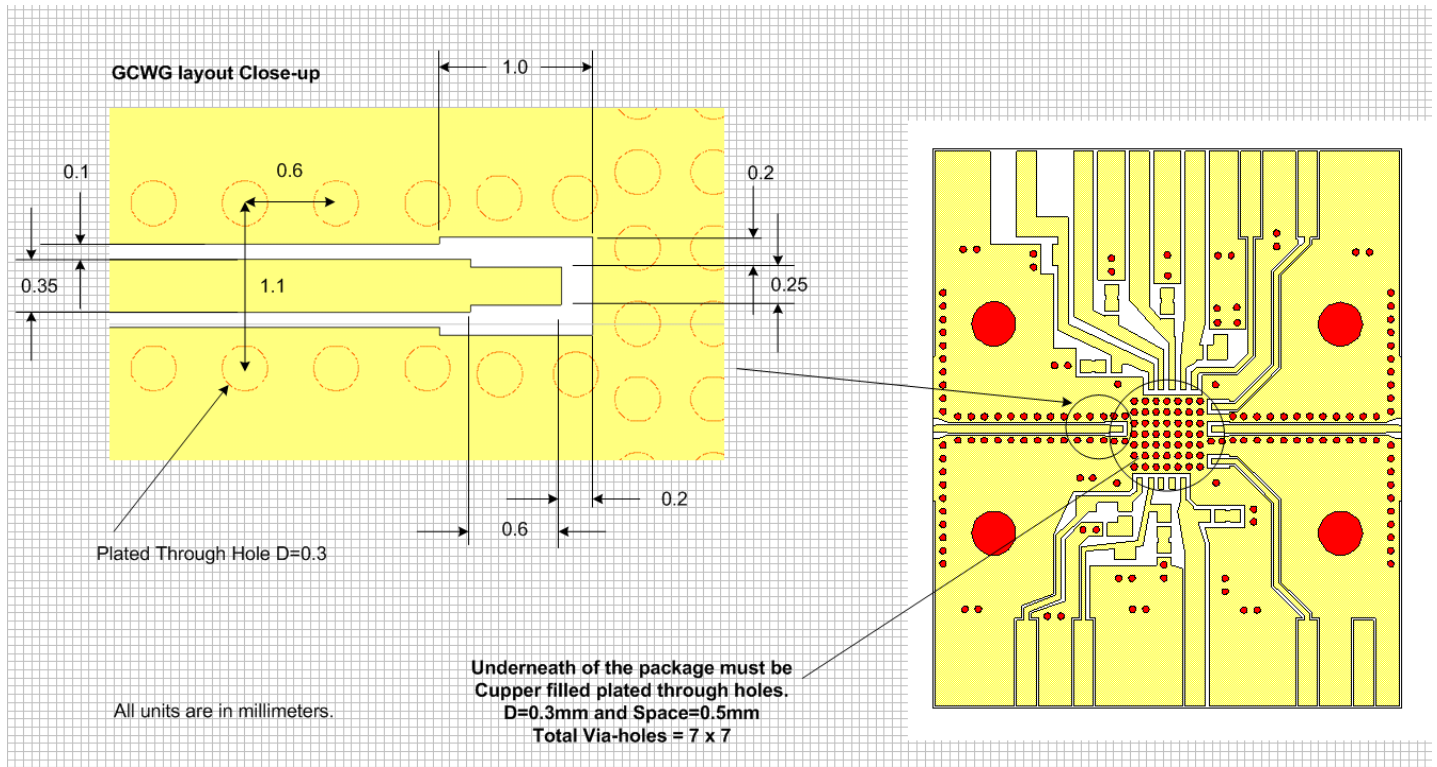

# **MMA-070936-M5**

**5GHz, 4W Power Amplifier**

## **Contact Information**

For additional information please visit [www.cmlmicro.com](http://www.cmlmicro.com) or contact a sales office.

<b>Europe</b>	<b>America</b>	<b>Asia</b>
<ul style="list-style-type: none"><li>• Maldon, UK</li><li>• Tel +44 (0) 1621 875500</li><li>• <a href="mailto:sales@cmlmicro.com">sales@cmlmicro.com</a></li></ul>	<ul style="list-style-type: none"><li>• Winston-Salem, NC</li><li>• Tel +1 336 744 5050</li><li>• <a href="mailto:us.sales@cmlmicro.com">us.sales@cmlmicro.com</a></li></ul>	<ul style="list-style-type: none"><li>• Singapore</li><li>• Tel +65 6288129</li><li>• <a href="mailto:sg.sales@cmlmicro.com">sg.sales@cmlmicro.com</a></li></ul>

Although the information contained in this document is believed to be accurate, no responsibility is assumed by CML for its use. The product and product information is subject to change at any time without notice. CML has a policy of testing every product shipped using calibrated test equipment to ensure compliance with product specification.

© 2017 CML Microsystems Plc